

|           |       |
|-----------|-------|
| PROJECT   | _____ |
| TYPE      | _____ |
| SPECIFIER | _____ |
| QUANTITY  | _____ |
| DATE      | _____ |

## IXION 3 ROD SUSPENSION

### D101542-

base number      LED Dimming      Color Temperature

- To build a product code in our configurator select the specify button on the base model # product page
- To build a manual product code on this datasheet choose from the options listed below in blue font and add the suffix to the base model #

#### GENERAL

Series: Ixion  
 Subseries: Ixion 3 rod  
 Brand: Quasar  
 Division: Design  
 Mounting Type: Suspension  
 Mounting Location: Ceiling  
 Subcategory: Pendant

#### PHYSICAL

Shape: Abstract  
 Length (mm): 1200  
 Length (in): 47 1/4  
 Height (mm): 30  
 Height (in): 1 3/16  
 Max. Overall Height (mm): 3030  
 Max. Overall Height (in): 119 5/16  
 Light Distribution: Omnidirectional  
 Weight (kg): 9  
 Weight (lbs): 19.84  
 Diffuser: Glass Half Matte / Half Clear  
 Fixture Material: Glass / Aluminum  
 Cable Details: 3000mm Cable

#### ELECTRICAL

Lamp Type: LED  
 Total Output Wattage (W): 43.2  
 Max. Wattage Per Lamp (W): 14.4  
 Dimming: [0-10V Dimming / Phase Dimming \(120Vac Only\)](#)  
 Driver Included: Yes  
 Driver Location: Integrated  
 Driver Type: Constant Voltage - Universal  
 Driver Class: Class 2  
 Input Voltage (V): 120 - 277  
 Output Voltage (V): 24  
 Upon Request: (Not included - see components) Integral: 0-10Vdc dimming / (Included) Integral: Phase dimming @120Vac only / 277Vac

#### LED

Number of LEDs: 3  
 Color Temperature (°K): [2400](#) / [2700](#) / [3000](#) / [4000](#)  
 Max. Delivered Lumen (lm): 2100 (2700K)  
 CRI: >90 CRI  
 Lamp Life (hrs): 50000

#### OPTICAL

#### RATINGS AND CERTIFICATIONS

Certified By: Certified for North American Standards  
 IP rating: IP20

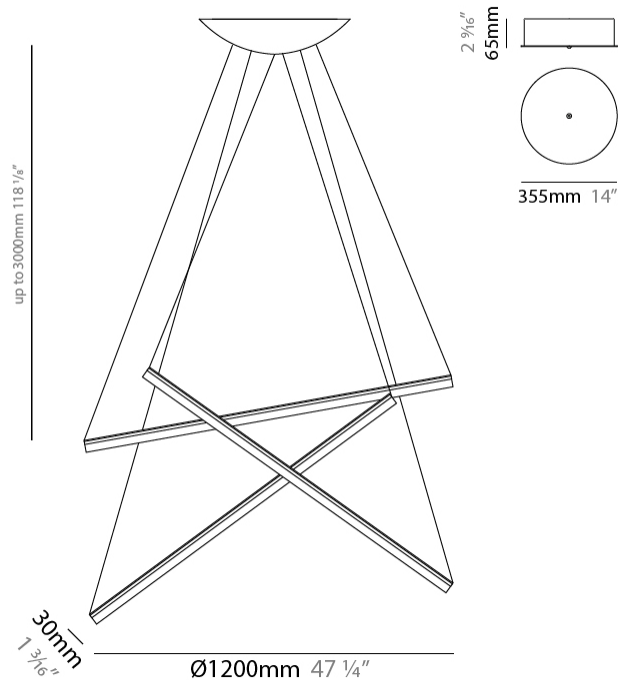

## IXION 3 ROD SUSPENSION

D101542-

|           |       |
|-----------|-------|
| PROJECT   | _____ |
| TYPE      | _____ |
| SPECIFIER | _____ |
| QUANTITY  | _____ |
| DATE      | _____ |

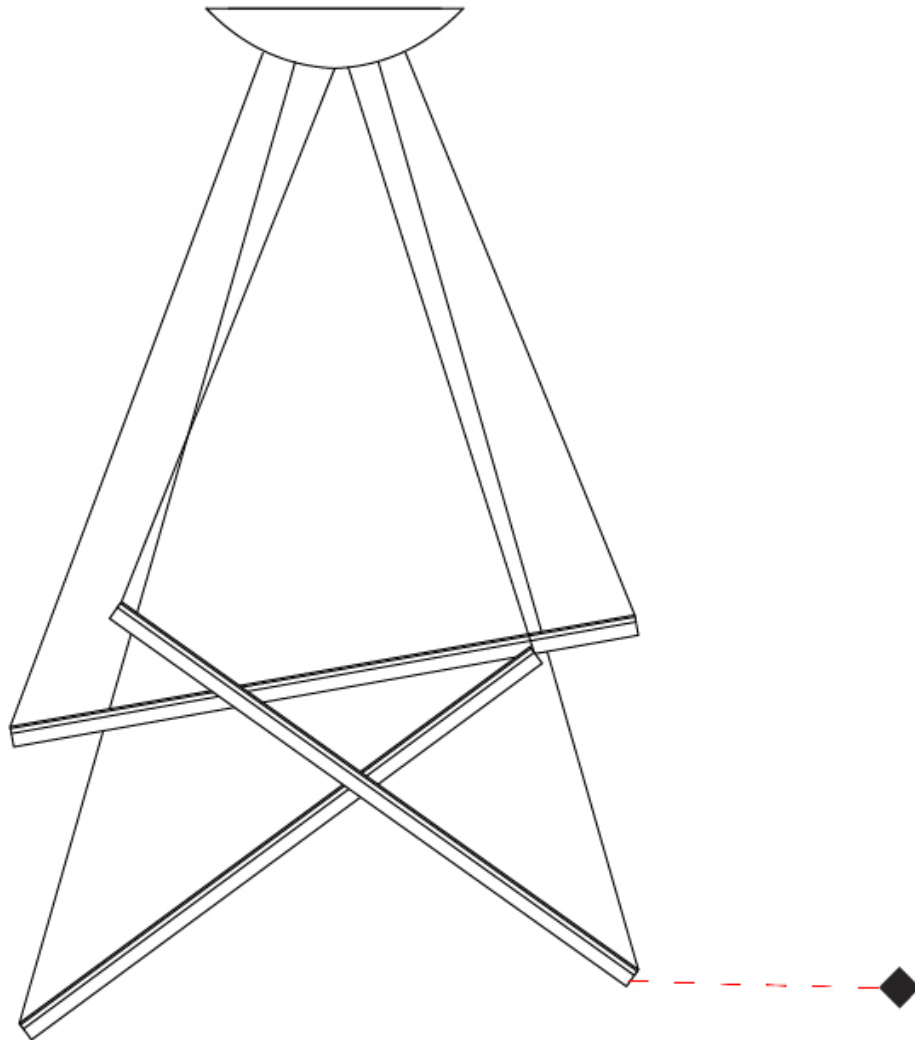

D

## IXION 5 ROD SUSPENSION

### D101543-

base number LED Dimming Color Temperature

- To build a product code in our configurator select the specify button on the base model # product page
- To build a manual product code on this datasheet choose from the options listed below in blue font and add the suffix to the base model #

#### GENERAL

Series: Ixion  
 Subseries: Ixion 5 rod  
 Brand: Quasar  
 Division: Design  
 Mounting Type: Suspension  
 Mounting Location: Ceiling  
 Subcategory: Pendant

#### PHYSICAL

Shape: Abstract  
 Length (mm): 1150  
 Length (in): 45 1/4  
 Height (mm): 30  
 Height (in): 1 3/16  
 Max. Overall Height (mm): 3030  
 Max. Overall Height (in): 119 5/16  
 Light Distribution: Omnidirectional  
 Weight (kg): 13  
 Weight (lbs): 28.66  
 Diffuser: Glass Half Matte / Half Clear  
 Fixture Material: Glass / Aluminum  
 Cable Details: 3000mm Cable

#### ELECTRICAL

Lamp Type: LED  
 Total Output Wattage (W): 72  
 Max. Wattage Per Lamp (W): 14.4  
 Dimming: 0-10V Dimming / Phase Dimming (120Vac Only)  
 Driver Included: Yes  
 Driver Location: Integrated  
 Driver Type: Constant Voltage - Universal  
 Driver Class: Class 2  
 Input Voltage (V): 120 - 277  
 Output Voltage (V): 24  
 Upon Request: (Not included - see components) Integral: 0-10Vdc dimming / (Included) Integral: Phase dimming @120Vac only / 277Vac

#### LED

Number of LEDs: 5  
 Color Temperature (°K): 2400 / 2700 / 3000 / 4000  
 Max. Delivered Lumen (lm): 3500 (2700K)  
 CRI: >90 CRI  
 Lamp Life (hrs): 50000

#### OPTICAL

#### RATINGS AND CERTIFICATIONS

Certified By: Certified for North American Standards  
 IP rating: IP20

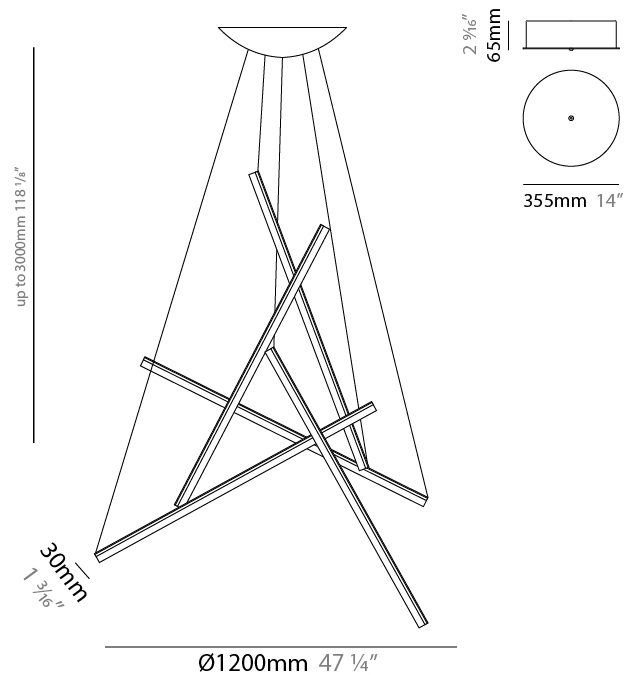

## IXION 5 ROD SUSPENSION

D101543-

PROJECT \_\_\_\_\_

TYPE \_\_\_\_\_

SPECIFIER \_\_\_\_\_

QUANTITY \_\_\_\_\_

DATE \_\_\_\_\_

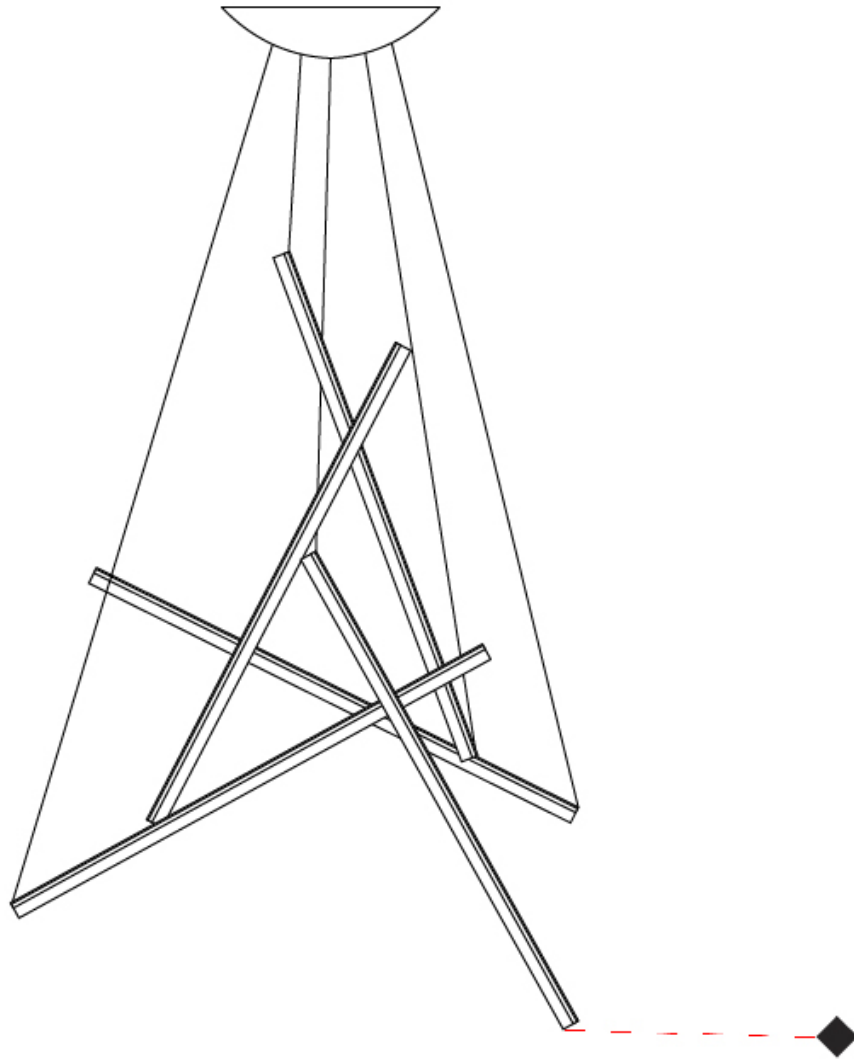

D

|           |       |
|-----------|-------|
| PROJECT   | _____ |
| TYPE      | _____ |
| SPECIFIER | _____ |
| QUANTITY  | _____ |
| DATE      | _____ |

## IXION 7 ROD SUSPENSION

### D101544-

base number      LED Dimming      Color Temperature

- To build a product code in our configurator select the specify button on the base model # product page
- To build a manual product code on this datasheet choose from the options listed below in blue font and add the suffix to the base model #

#### GENERAL

Series: Ixion  
 Subseries: Ixion 7 rod  
 Brand: Quasar  
 Division: Design  
 Mounting Type: Suspension  
 Mounting Location: Ceiling  
 Subcategory: Pendant

#### PHYSICAL

Shape: Abstract  
 Length (mm): 1200  
 Length (in): 47 1/4  
 Height (mm): 30  
 Height (in): 1 3/16  
 Max. Overall Height (mm): 3030  
 Max. Overall Height (in): 119 5/16  
 Light Distribution: Omnidirectional  
 Weight (kg): 15  
 Weight (lbs): 33.07  
 Diffuser: Glass Half Matte / Half Clear  
 Fixture Material: Glass / Aluminum  
 Cable Details: 3000mm Cable

#### ELECTRICAL

Lamp Type: LED  
 Total Output Wattage (W): 100.8  
 Max. Wattage Per Lamp (W): 14.4  
 Dimming: [0-10V Dimming / Phase Dimming \(120Vac Only\)](#)  
 Driver Included: Yes  
 Driver Location: Integrated  
 Driver Type: Constant Voltage - Universal  
 Driver Class: Class 2  
 Input Voltage (V): 120 - 277  
 Output Voltage (V): 24  
 Upon Request: (Not included - see components) Integral: 0-10Vdc dimming / (Included) Integral: Phase dimming @120Vac only / 277Vac

#### LED

Color Temperature (°K): [2400 / 2700 / 3000 / 4000](#)  
 Max. Delivered Lumen (lm): 4900 (2700K)  
 CRI: >90 CRI  
 Lamp Life (hrs): 50000

#### OPTICAL

#### RATINGS AND CERTIFICATIONS

Certified By: Certified for North American Standards  
 IP rating: IP20



## IXION 7 ROD SUSPENSION

D101544-

|           |       |
|-----------|-------|
| PROJECT   | _____ |
| TYPE      | _____ |
| SPECIFIER | _____ |
| QUANTITY  | _____ |
| DATE      | _____ |

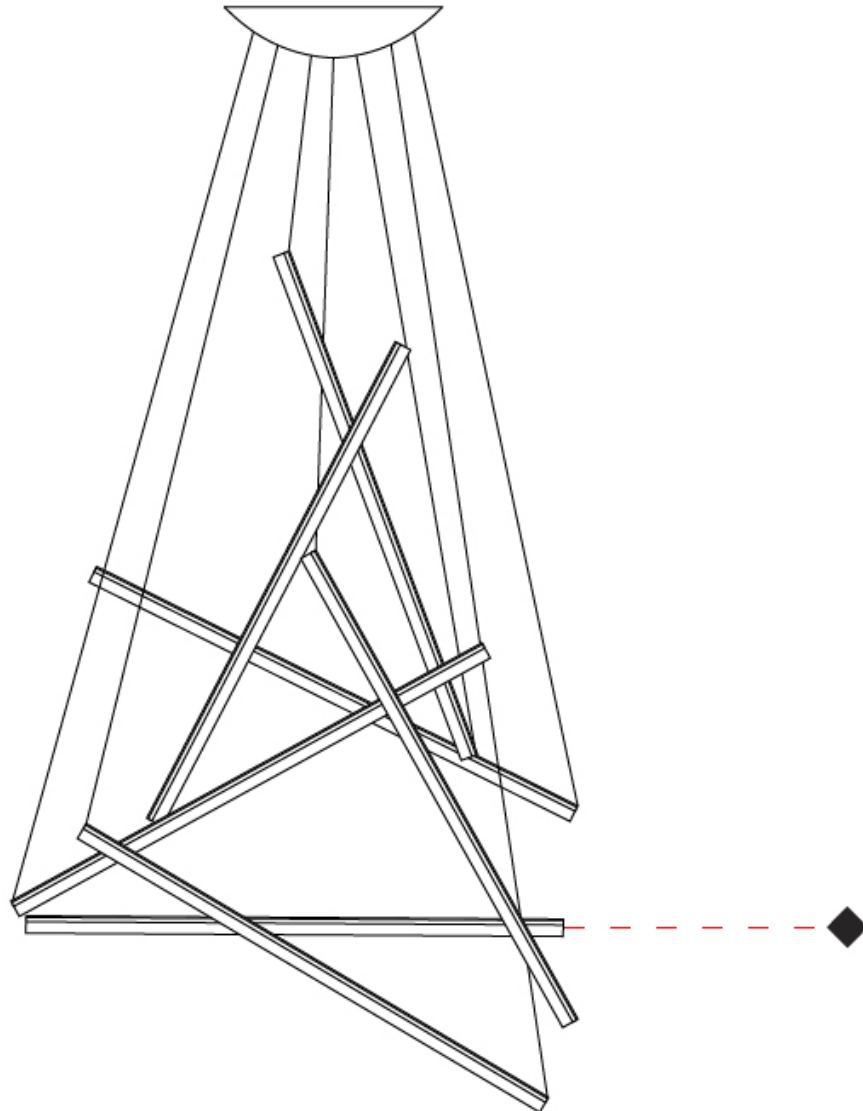

D

|           |       |
|-----------|-------|
| PROJECT   | _____ |
| TYPE      | _____ |
| SPECIFIER | _____ |
| QUANTITY  | _____ |
| DATE      | _____ |

## IXION SUSPENSION

### D101830-

base number      LED Dimming      Color Temperature

- To build a product code in our configurator select the specify button on the base model # product page
- To build a manual product code on this datasheet choose from the options listed below in blue font and add the suffix to the base model #

#### GENERAL

Series: Ixion  
 Brand: Quasar  
 Division: Design  
 Mounting Type: Suspension  
 Mounting Location: Ceiling  
 Subcategory: Ambient

#### PHYSICAL

Shape: Rectangle  
 Length (mm): 1200  
 Length (in): 47 3/4  
 Height (mm): 30  
 Height (in): 1 3/16  
 Max. Overall Height (mm): 2030  
 Max. Overall Height (in): 79 15/16  
 Light Distribution: Omnidirectional  
 Weight (kg): 5  
 Weight (lbs): 11  
 Diffuser: Glass Half Matte / Half Clear  
 Fixture Material: Glass / Aluminum  
 Cable Details: 2000mm Cable

#### ELECTRICAL

Lamp Type: LED  
 Total Output Wattage (W): 14.4  
 Dimming: 0-10V Dimming / Phase Dimming (120Vac Only)  
 Driver Included: Yes  
 Driver Location: Integrated  
 Driver Type: Constant Voltage - Universal  
 Driver Class: Class 2  
 Input Voltage (V): 120 - 277  
 Output Voltage (V): 24  
 Upon Request: (Not included - see components) 0-10Vdc dimming / (Included) Phase dimming @120Vac only / Non-dimming @277Vac

#### LED

Number of LEDs: 1  
 Color Temperature (°K): 2400 / 2700 / 3000 / 4000  
 Max. Delivered Lumen (lm): 700 (2700K)  
 CRI: >90 CRI  
 Lamp Life (hrs): 50000

#### OPTICAL

#### RATINGS AND CERTIFICATIONS

Certified By: Certified for North American Standards  
 IP rating: IP20

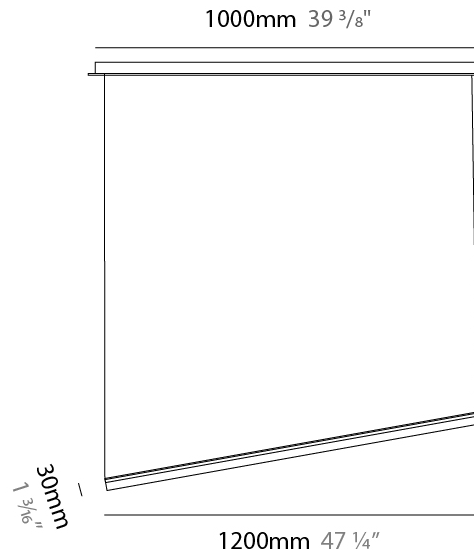
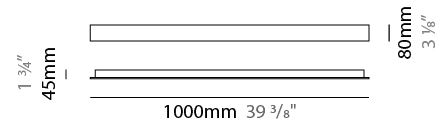
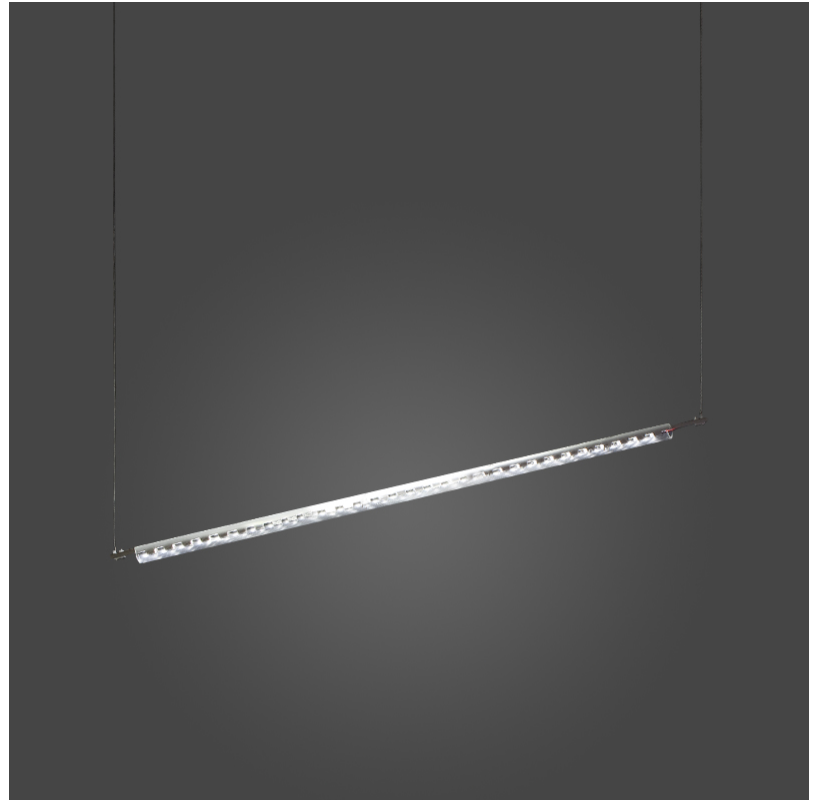

D101830-

PROJECT

TYPE

SPECIFIER

QUANTITY

DATE

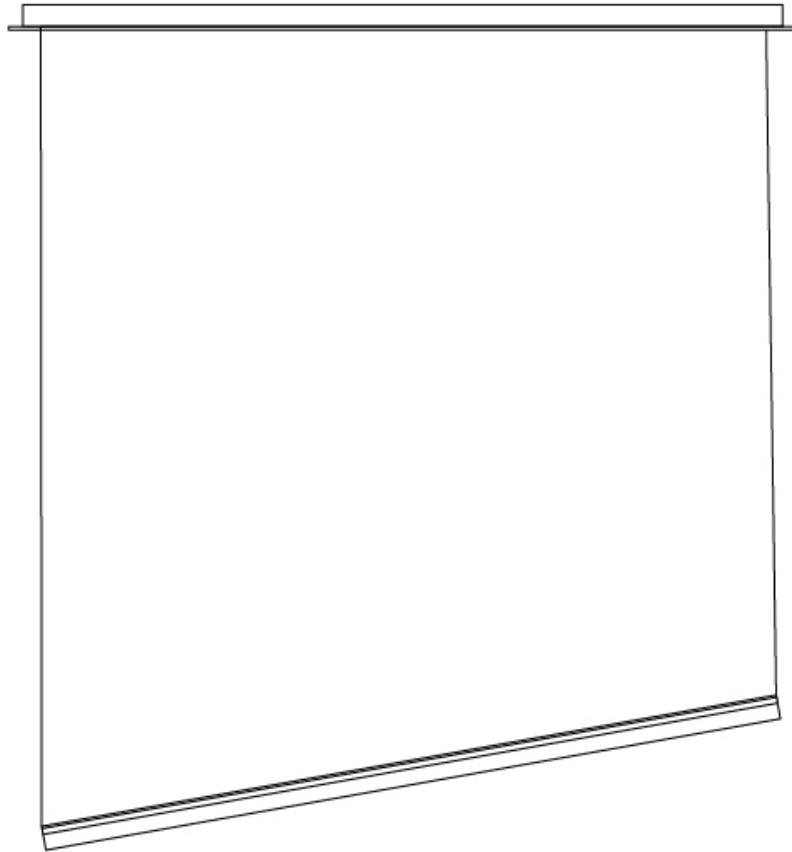



PROJECT

TYPE

SPECIFIER

QUANTITY

DATE

#### Fixture Finish

**Digital:** Not all screens are calibrated the same, and therefore, colors will appear differently between screens.

**Physical:** When texture is involved, there will be variations in color, character and tone within a product series and between product families.













|           |  |
|-----------|--|
| PROJECT   |  |
| TYPE      |  |
| SPECIFIER |  |
| QUANTITY  |  |
| DATE      |  |











### LEGEND

|  |  |  |
|--|--|--|
|  floor-mounted   |  pivotable  |  special LED (upon request) RGB, RGBW, tunable, gold+, meat+, art+, fashion+                    |
|  wall and ceiling: recessed and surface mounted              |  rotating   |  warm dim / natural dimming LED   |
|  ceiling-mounted and wall-mounted                            |  illuminate tilted  |  rechargeable battery powered   |
|  wall-mounted  |  color of suspension cable                                    |  fixture with natural vivid LED (upon request)  |
|  omni-directional light distribution                         |  length of suspension cable                                   |  color rendering index  |
|  direct light distribution                                   |  reflector degree selection                                   |  color temperature  |
|  direct/indirect light distribution                          |  super spot   |  lumen (luminous flux)  |
|  indirect light distribution                                 |  lens   |  efficacy (lumens per watt)   |
|  asymmetric light distribution                               |  lens pack  |  Unified Glare Rating (UGR) range from 5-40   |
|  aura light distribution                                     |  shine ring   |  marine grade (AISI 316 stainless steel)  |
|  round wall or ceiling cut-out                               |  integrated shine ring with diffuser                          |  walk on  |
|  square wall or ceiling cut-out                              |  free individual colors 01-29                                 |  drive on   |
|  the supplied jig specifies the cutout dimensions            |  individual colors: 00 (free of charge), 01-25 (extra charge) |  Dark Sky Compliance  |
|  minimum distance (meters) lamp - object                     |  luminaire part to be colored (F1)                            |  Americans with Disabilities Act (less than 4" off the wall located between 27"-84" from floor) |
|  recessed depth  |  luminaire part to be colored (F2)                            |  lamp protected against explosion   |
|  ceiling thickness in mm                                    |  luminaire part to be colored (F3)                           |  blown glass using traditional methods by master glass blower                                  |
|  ceiling thickness selection                               |  luminaire part to be colored (F4)                          |  acoustic material  |
|  dimmable DP (phase), DV (0-10V), DD (dali), DS (step-dim) |  luminaire part to be colored (F5)                          |  protection class I, protection insulation  |
|  included or excluded LED driver/transformer/control gear  |  color of 3-circuit adaptor                                 |  protection class II, protection insulation   |
|  separately switchable                                     |  indirect diffuser  |  ETL Certified to UL and CSA Standards  |
|  sensor  |  direct diffuser  |  UL Certified to UL and CSA Standards   |
|  remote control  |  ball-proof (upon request)                                  |  CSA Certified to UL and CSA Standards  |
|  available upon request                                    |  accessory  |  Certified for North American Standards   |

### IP RATING

|  |  |
|--|--|
|  IP20 | protected against ingress of solid bodies greater than 12.5mm (finger)   |
|  IP33 | protected against ingress of solid bodies greater than 2.5mm<br>protected against sprays of water up to 60 degrees from the vertical (rain)      |
|  IP40 | protected against ingress of solid bodies greater than 1mm (wire)<br>no protection against the ingress of moisture                               |
|  IP43 | protected against ingress of solid bodies greater than 1mm (wire)<br>protected against sprays of water up to 60 degrees from the vertical (rain) |
|  IP44 | protected against ingress of solid bodies greater than 1mm (wire)<br>protected against water splashed from all directions                        |
|  IP54 | protected against limited ingress of dust (wet rooms/covered outdoor areas)<br>protected against water splashed from all directions              |
|  IP65 | protected against ingress of dust<br>protected against jets of water   |
|  IP66 | protected against ingress of dust<br>protected against powerful jets of water or heavy seas  |
|  IP67 | protected against ingress of dust<br>protected against immersion of water between 15cm - 1m for 30 minutes                                       |
|  IP68 | protected against ingress of dust<br>protected against immersion of water under pressure for long periods  |

### IK RATING

|  |   |
|--|---|
|  IK01 | protected against 0.14 joules impact (equivalent to 0.25kg mass dropped from 56mm above the surface)  |
|  IK02 | protected against 0.2 joules impact (equivalent to 0.25kg mass dropped from 80mm above the surface)   |
|  IK03 | protected against 0.35 joules impact (equivalent to 0.25kg mass dropped from 140mm above the surface) |
|  IK04 | protected against 0.5 joules impact (equivalent to 0.25kg mass dropped from 200mm above the surface)  |
|  IK05 | protected against 0.7 joules impact (equivalent to 0.25kg mass dropped from 280mm above the surface)  |
|  IK06 | protected against 1 joules impact (equivalent to 0.25kg mass dropped from 400mm above the surface)    |
|  IK07 | protected against 2 joules impact (equivalent to 0.5kg mass dropped from 400mm above the surface)     |
|  IK08 | protected against 5 joules impact (equivalent to 1.7kg mass dropped from 300mm above the surface)     |
|  IK09 | protected against 10 joules impact (equivalent to 5.0kg mass dropped from 200mm above the surface)    |
|  IK10 | protected against 20 joules impact (equivalent to 5.0kg mass dropped from 400mm above the surface)    |